

VM ZINC roofing ornaments by Ateliers d'Art Français



A Umicore brand



CONTENTS

Visit our website: www.ornamentation.com



Finials 4-5
Finials, pinnacles, flames



Weather vanes 6-9
Stamped weather vanes
Silhouette weather vanes
Arrows and pennants
Cardinal points
Compositions



Bull's eye and dormer windows 10-12
Decorative motifs for Bull's eye and dormer windows



Downpipes 13
Pipes, bends, overflows, gargoyles



Stamped designs 14-15
Double roofcaps, galleries, canopies, scallops

INHERITING A NOBLE ART

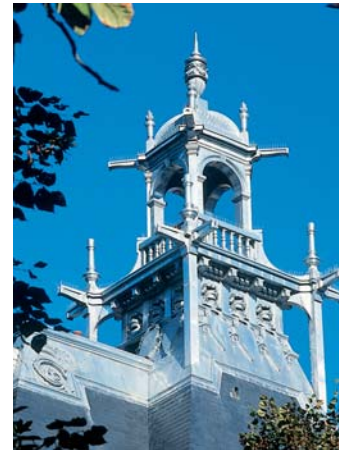

For over a century, the Ateliers d'Art Français have adorned the roofs of our towns and villages with their zinc ornaments.

The Ateliers d'Art Français are the only direct descendants of the ornamental metal workers in France of the 19th Century and have been making ornaments in zinc, copper and lead for over 150 years.

Ornamental metalworking is much more than a job, it is an art, the know-how of which is passed directly from the skilled ornamental metal worker to the apprentice. True to the tradition of the arts, the apprentice inherits an age-old tradition through contact with experienced ornamental metalworkers and through day-to-day experience.

Over the years, the Ateliers d'Art Français have collected old catalogues,

architectural plans and dies which enable them to make identical reproductions of period pieces and thus contribute to the conservation of an ancient heritage.

Today the Ateliers d'Art Français offer a range of over 300 decorative catalogue items, some of which date back more than a century and are divided into five main categories:

- Finials, pinnacles and flames,
- Weathervanes and compositions,
- Dormer and bull's eye windows,
- Panels of stamped scales and decorated rainwater downpipes,
- Stamped designs.

The quality of the work of the Ateliers d'Art Français acts as a benchmark for professionals who are asked to work on an ornamentation project.

Ateliers d'Art Français is a brand of the Umicore Group which also produces VM ZINC rolled zinc.



FINIALS, PINNACLES AND FLAMES



4067

All our finials are available in natural zinc and copper. For finials higher than 40 cm a fixing rod has to be used. The heights of finials for supporting weathervanes are in bold type and marked by a ❖.



3412

Height **90 and 180 cm** ❖



4060

Height 30, 40, 50, 60, 80 and 100 cm



4062

Height 50, 70 and 90 cm



3701

Height **100, 150 and 200 cm** ❖



3414

Height 40, 55 and 70 cm



3459

Height 50 cm



3463

Height 45, 60, **90 and 120 cm** ❖



4015

Height 100, **160 cm** ❖



4063

Height 45, 70, **90 and 120 cm** ❖

Square finials



4115

Height 65 and 80 cm



3481

Height 80, 100, 125 and 150 cm

All the square finials are mounted without a fixing rod.

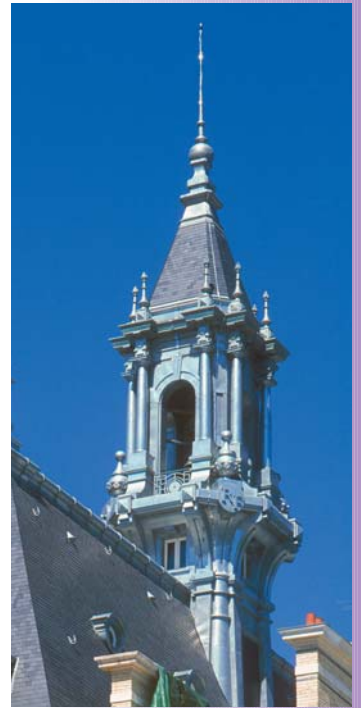

Pinnacle finials

All the pinnacle finials are mounted without a fixing rod.



4064

Height 120, 145 and 175 cm



3601

Height 30 and 40 cm



4146

Height 60 cm



4148

Height 120 cm



4067

Height 100, 120 and 150 cm

Flames



4498

Height 43 cm



STAMPED WEATHERVANES

Our weathercocks can be mounted on all types of rods. Indicate the diameter or the taper.



2242

Breadth 50 cm

For the breadth of weathercocks 2242 and 4154 from 40 to 90 cm, consult us.



2333

Breadth 40, 55, 70 et 97 cm



2336

Breadth 40, 55, 70 and 97 cm



4154

Breadth 40 and 50 cm



2211

Breadth 55 cm

For this range of stamped weathervanes we offer the following models: Chimera, pigeon, ox, lion and horse. They are available in natural zinc and in copper.



2280

Breadth 25 et 40 cm



2547

Breadth 75 cm



2609

Breadth 55 cm

N.B. : The pigeon model does not work well as a weathervane.



2650

Breadth 69 cm



4159

Breadth 35 cm



4161

Breadth 55 cm

SILHOUETTE WEATHERVANES



4169

Breadth 58 cm

Personalised designs tailor-made from a drawing or photograph according to estimate.



2159

Breadth 72 cm



2137

Breadth 65 cm



2160

Breadth 75 cm



2151

Breadth 60 cm



4173

Breadth 62 cm



2158

Breadth 78 cm



4178

Breadth 64 cm

SILHOUETTE WEATHERVANES

Arrows and pennants in catalogue

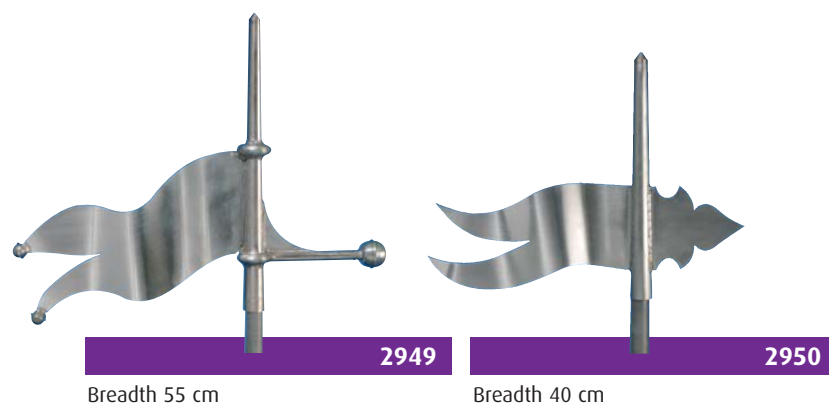
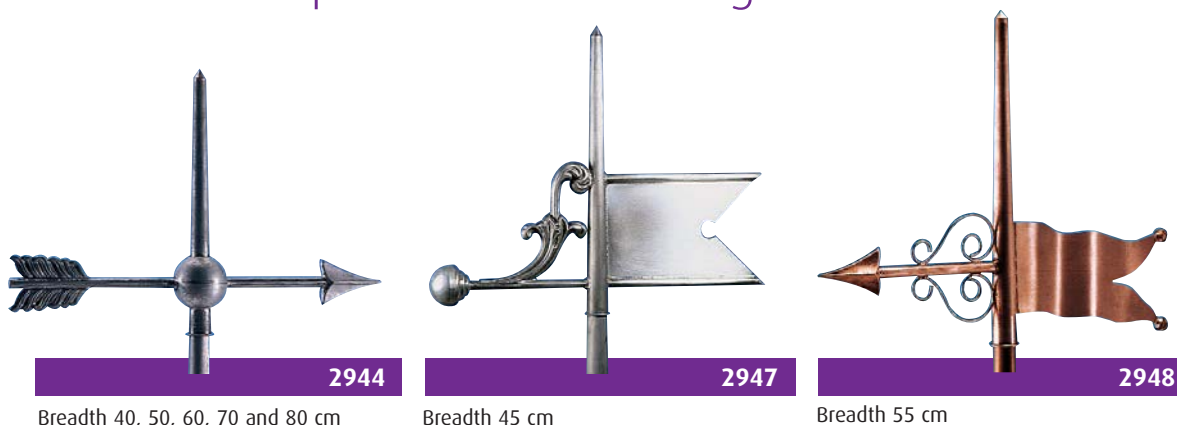

Cardinal points in catalogue

Any letters can be made on consultation.

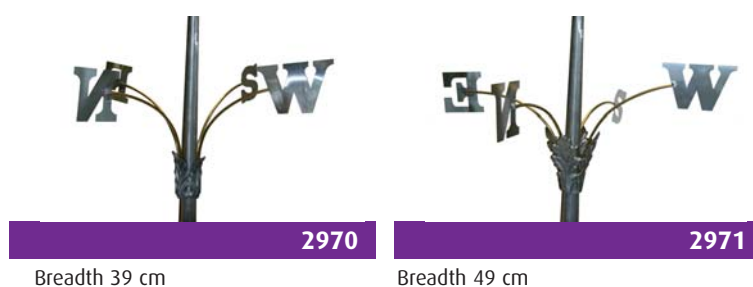
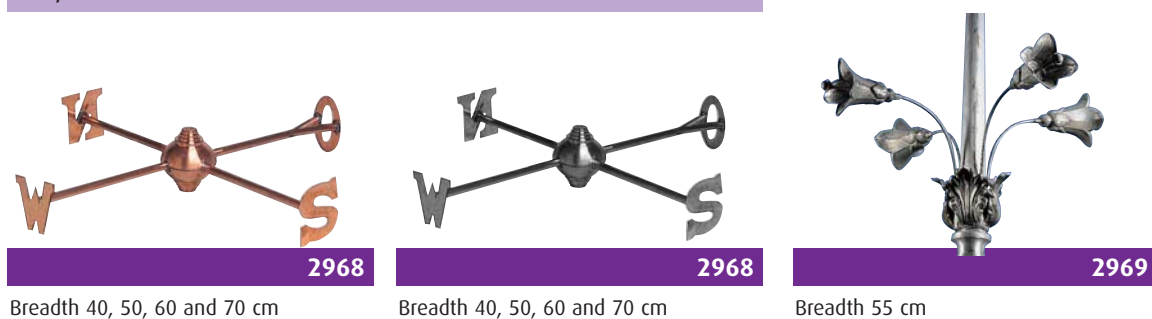

COMPOSITIONS



1 2 Compositions with stamped weathervane



4218

Reference 4218

Height 120 cm made up of:

- finial ref. 4063.
- Cardinal points specific to this composition
- Arrow weathervane ref. 2948.

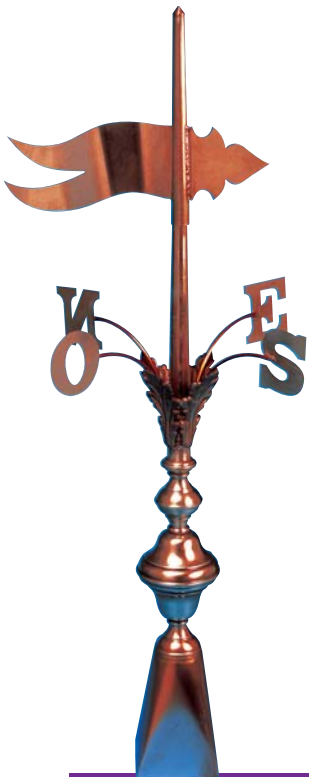
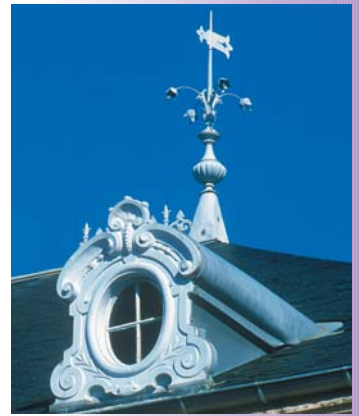

3440

Reference 3440

Height 100, 150 and 200 cm made up of:

- finial ref. 3701.
- cardinal points ref. 2971.
- pennant weathervane ref. 2950.



4055

Reference 4055

Height 155 cm made up of:

- finial ref. 4064.
- cardinal points ref. 2969.
- pennant weathervane ref. 2947.



4090

Reference 4090

Height 120 cm made up of:

- finial ref. 4063.
- cardinal points specific to this composition.
- arrow weathervane ref. 2944.



BULL'S EYE WINDOWS



3024

All our catalogue bull's eye and dormer windows are supplied either as front only for facade mounting or with a slope and shaped collar. This range is available in the standard designs and dimensions listed, in natural zinc, QUARTZ-ZINC, ANTHRA-ZINC and copper.

The models shown are for new construction. Their use in renovations may require modifications to the roof frame (consult us).



3020



3022



3023

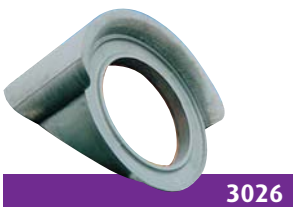

3026



3065



3066



3067



4205



4206



4211

Ref. n°	Opening in m.	Overall in m.	
		Height	Width
3020 and 3021*	0.60 x 0.40	0.97	0.95
	0.65 x 0.50	1.04	1.06
	0.70 x 0.50	1.13	1.16
	0.80 x 0.60	1.29	1.31
	0.90 x 0.60	1.40	1.31
3022	0.60 x 0.40	0.96	1.00
	0.65 x 0.50	1.03	1.12
	0.70 x 0.50	1.08	1.12
	0.80 x 0.60	1.21	1.27
	0.90 x 0.60	1.31	1.27
3023	diam. 0.75	1.23	1.27
3024 and 3025*	0.50 x 0.40	0.95	0.78
	0.65 x 0.50	1.18	1.00
	0.70 x 0.50	1.23	1.00
	0.80 x 0.60	1.38	1.10
	0.90 x 0.60	1.48	1.16
3026	diam. 0.75	1.18	1.28
3065	diam. 0.25	0.46	0.46
3066	diam. 0.35	0.86	0.86
	diam. 0.40	0.98	0.98
	diam. 0.45	1.02	1.02
	diam. 0.50	1.07	1.07
	diam. 0.60	1.23	1.23
	diam. 0.65	1.32	1.32
3067	diam. 0.75	1.43	1.43
	0.65 x 0.50	1.20	1.10
	0.70 x 0.50	1.20	1.10
	0.80 x 0.60	1.35	1.23
	0.90 x 0.60	1.47	1.23
4205	diam. 0.25	0.49	0.54
	diam. 0.28	0.53	0.58
	diam. 0.32	0.57	0.62
	diam. 0.38	0.69	0.74
	diam. 0.60	1.07	1.16
4206	0.45 x 0.32	0.74	0.72
	0.65 x 0.50	1.07	1.11
	0.70 x 0.50	1.12	1.11
	0.80 x 0.60	1.20	1.32
	0.90 x 0.60	1.40	1.32
4211	diam. 0.50	1.08	1.16
	diam. 0.60	1.30	1.39
	diam. 0.75	1.52	1.65
	diam. 0.90	1.94	2.08

* : Identical to the preceding model without decorative motif.

DORMER WINDOWS



4203

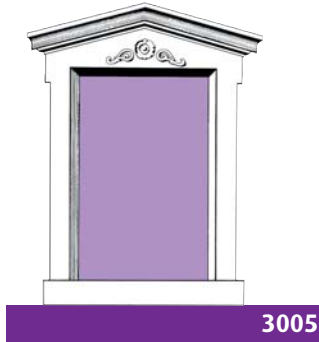

3005



Ref. n°	Opening in m.	Overall in m.	
		Height	Width
3005	1.40 x 0.80	2.03	1.47
	1.60 x 0.95	2.34	1.71
3011	0.90 x 0.55	1.50	1.22
	0.90 x 0.70	1.50	1.37
	1.20 x 0.80	1.88	1.58
3012	0.90 x 0.55	1.36	1.17
3015	0.90 x 0.60	1.46	1.08
	1.00 x 0.75	1.68	1.38
	1.20 x 0.95	2.00	1.68
	1.40 x 1.15	2.24	1.88
3460	1.00 x 0.60	1.34	1.08
3494	1.00 x 0.60	1.69	1.22
	1.30 x 0.75	2.09	1.48
4203	0.75 x 0.46	1.12	1.04
	0.90 x 0.55	1.33	1.16
4204	0.75 x 0.46	1.06	1.04
	0.90 x 0.55	1.27	1.17



3011



3012

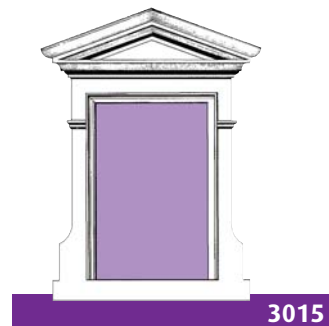

3015



3460

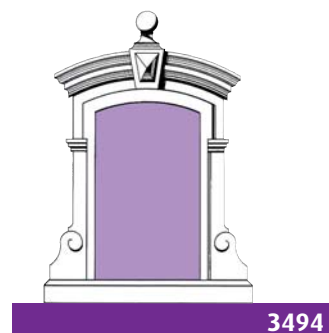

3494



4204



DECORATIVE MOTIFS FOR BULL'S EYE AND DORMER WINDOWS



2282

Dimensions H 40-W 31 cm

All our decorative motifs are sold exclusively with the bull's eyes and dormers they are designed for. The decorative motifs are available in natural zinc and copper. They can be tailor made from an original model as part of a full restoration of the ornament (consult us).



0605

Dimensions H 32-W 27 cm



0630

Dimensions H 20-W 18 cm



2281

Dimensions H 28-W 26.5 cm



2283

Dimensions H 50-W 35.5 cm



2289

Dimensions H 40-W 36 cm



4396

Dimensions H 47-W 35 cm



4399

Dimensions H 43-W 39 cm



4401

Dimensions H 44-W 35 cm



4411

Dimensions H 29-W 21.5 cm

DOWNPIPES



4700

Section 14+5.5x5 cm
Lenght 1 lm



1873

Diameter 8, 10 and 12 cm
Lenght 1 lm

Ornamental
downpipes

Fluted
bends



2457

Diameter 8, 10
and 12 cm

Decorative Hopperheads



4707

Diameter 8, 10 and 12 cm



2279

Diameter 8, 10, 12 and 14 cm



2286

Diameter 8, 10, 12 and 16 cm



Rainwater
shoes

2458

Diameter 8, 10 and 12 cm

Gargoyles



2262

Diameter 4, 6, 8 and 10 cm



STAMPED DESIGNS

Double roofcaps



Height 69.5 cm

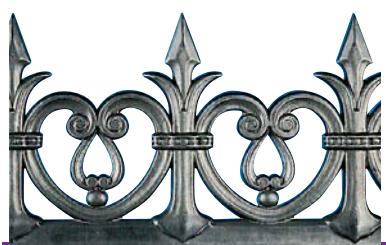

2085

Height 27 cm



2255

Height 30.5 cm



2506

Height 40 cm



2615

Height 21.5 et 35 cm



2710

Height 38 cm



4020

Height 84.5 cm



4033

Height 49.5 cm



4042

Height 30 cm

Galleries



1675

Height 15 cm



1850

Height 13 cm



2045

Height 8 cm



2185

Height 14 cm



2241

Height 12 cm



4676

Height 18 cm

Canopies

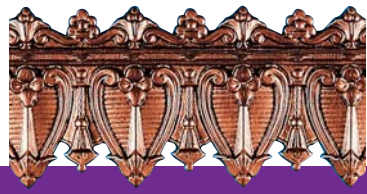

2155

Height 19 cm



2178

Height 22 cm



2179

Height 32 cm

Scallops

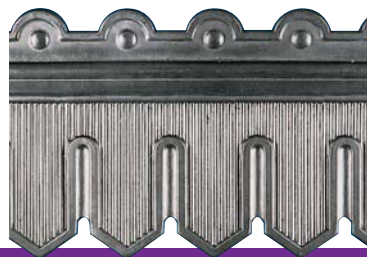

2834

Height 35 cm



4668

Height 40 cm

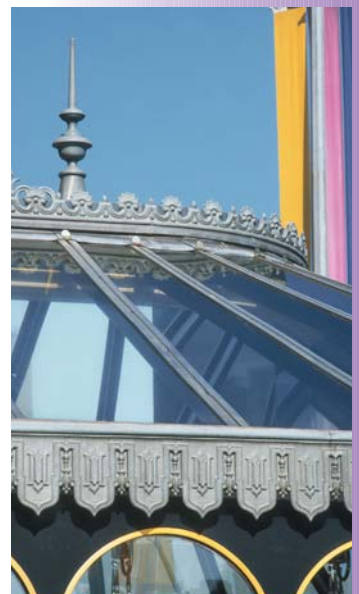
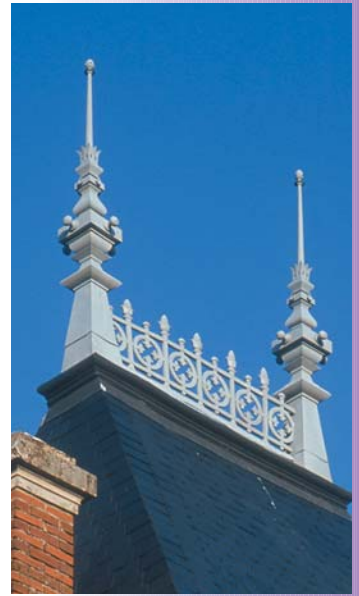

SUBSIDIARIES

AUSTRALIA/NEW ZEALAND

Umicore Australia
Po Box 727
Crows Nest - NSW 2065
Australia
Tel.: + 61 2 99 55 44 00
Fax: + 61 2 99 55 11 44

BELGIUM LUXEMBOURG

n.v. Umicore s.a. Building Products
Belgium
Havendoklaan, 12b - B1800 Vilvoorde
Tel.: + 32 2 7125211
Fax: + 32 2 7125210

CZECH/SLOVAK REPUBLIC

Umicore Building Products CZ s.r.o.
Pod Visnovkou 1661/31
Praha 4 - Krc - 140 00
Czech Republic
Tel.: + 420 234 036 240
Fax: + 420 234 036 241

DENMARK/NORWAY/SWEDEN

Umicore Marketing Services
Scandinavia A/S
Lysbrohøjen 5 -DK- 8600 Silkeborg
Denmark
Tel.: + 45 86 84 80 05
Fax: + 45 86 84 89 05

FRANCE

Umicore France s.a.s./Ateliers d'Art Français
40, Rue Jean Jaurès
93176 Bagnolet Cedex
Tel.: + 33 1 49 72 43 40
Fax: + 33 1 49 72 43 42
ateliersdartfrancais@umicore.com

GERMANY

Umicore Bausysteme GmbH
Hafenstraße 280 - 45356 Essen
Tel.: + 49 201 836060
Fax: + 49 201 8360660

GREAT BRITAIN

Umicore Marketing Services UK Ltd.
Four Rivers House, Fentiman Walk
Hertford, Herts, SG14 1DB
Tel.: + 44 1992 822288
Fax: + 44 1992 584460

HONG KONG

Umicore Marketing Services (Far East) Limited
Unit A-B, 19/F, Manulife Tower
169 Electric Road
Hong Kong
Tel.: + 852 2700 0000
Fax: + 852 2807 2440

HUNGARY

Umicore Magyar Marketing
Szolgáltató Kft.
Kagyló u. 4-6, POB : 101
H-2092 Budakeszi
Tel.: + 36 23 452452
Fax: + 36 23 452320

ITALY

Umicore Marketing Services Italia S.r.l.
Via Fieno 8 - 20123 Milano
Tel.: + 39 02 86.350.229
Fax: + 39 02 86.350.413

POLAND

Umicore Marketing Services
Polska Sp z o.o.
ul. Ludwiki 4
01-226 Warszawa
Tel.: + 48 22 632 47 61
Fax: + 48 22 632 46 40

PORTUGAL

Umicore Portugal S.A.
Travessa do Padrão
4455 524 Perafita
Tel.: + 35 1 22 995 0167
Fax: + 35 1 22 995 4801

SINGAPORE

Umicore Singapore Pte Ltd
N° 2, Corporation Road, #06-16/17
Corporation Place (Lobby A)
618494 Singapore
Tel.: + 65 6898 3936
Fax: + 65 6265 7118

SPAIN

Umicore Building Products Ibérica S.L.
Torres Cerdá
C/General Almirante 4, 6ª Planta
08014 Barcelona
Tel.: + 34 932988880
Fax: + 34 934219568

SWITZERLAND

Umicore Marketing Services AG
Industriestrasse 25 - 3178 Bödingen
Tel.: + 41 317475868
Fax: + 41 317475867

THE NETHERLANDS

n.v. Umicore s.a. Building Products
Belgium
Havendoklaan, 12b - B1800 Vilvoorde
Tel.: + 31 20 494 28 39
Fax: + 31 20 494 08 46

USA

Main Office
Umicore Building Products USA Inc.
Magnolia Building, Suite 104
3120 Highwoods Boulevard
Raleigh, NC 27604
Tel.: + 1 919 874 7173
Fax: + 1 919 874 7140

West Coast Office

208 Southwest 1st Avenue
Suite 304
Portland - OR 97204
Tel.: + 1 503 827 0600
Fax: + 1 503 827 0770

REPRESENTATIVES

ARGENTINA

KORZIN S.A.C.I.
Pueyrredón 4233
(B1702ASY) Ciudadela
Pcia Buenos Aires
Tel.: + 54 11 4653 1425
Fax: + 54 11 4657 6961

AUSTRIA

VM ZINC Center Österreich
Seitenhafenstraße 7
1020 Wien
Tel.: + 43 1 726 34 34
Fax: + 43 1 720 37 37 20

CANADA

Canadian Brass and Copper Co.
225 Doney Crescent
Concord, Ontario - LK4 1P6
Tel.: + 416 736 0797
Fax: + 416 736 7510

GREECE

MIPECO Trading Ltd
55, Souliou Street
190 02 Peania (Athina)
Tel.: + 30 210 664 46 11
Fax: + 30 210 664 38 25

KOREA

SUNNIE INTERNATIONAL
Bangbae - 3 Dong 488-1
Seocho-Ku
Seoul 137-063
Tel.: + 82 2-525 0322
Fax: + 82 2-3471-5718

LEBANON

NAGGIAR
Naggiar Building - Hobeika Street
Saifi - Beyrouth
Code postal: 2029 6406
Tel.: + 961 1 562 652
Fax: + 961 1 448 391

WEB SITE

www.ornamentation.com